

FY2024 Supplement IWG-to-PCA Mapping

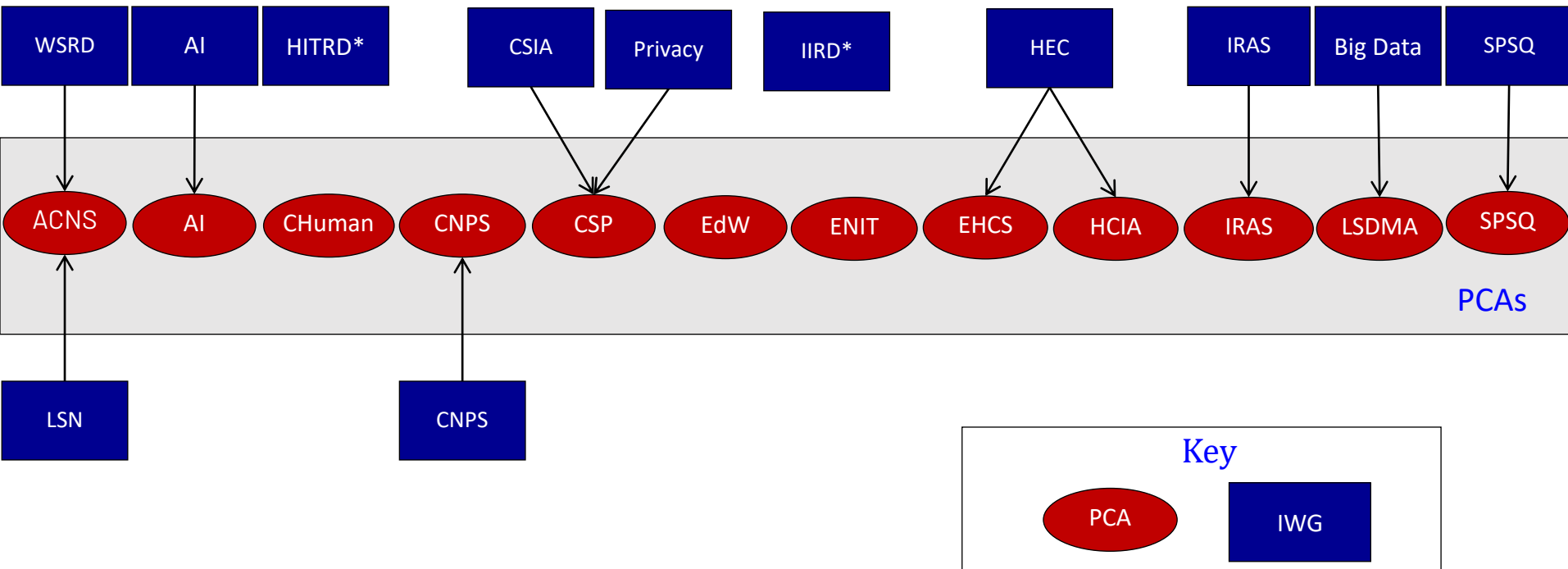

For annual NITRD Supplement, agencies “map” their NITRD Program activities coordinated by IWGs into Supplement sections and budgets organized by PCAs. Predominant FY2024 mapping by agencies:



* The HITRD and IIRD IWGs are special interest groups with investments reported across several PCAs. Investments in the CHuman and EdW PCAs are crosscutting among all the IWGs